



2+



2



0,6m



1 = 0,9m  
2 = 0,3m  
3 = 0,79m



Discapacidad motriz  
Discapacidad sensorial  
Discapacidad mental

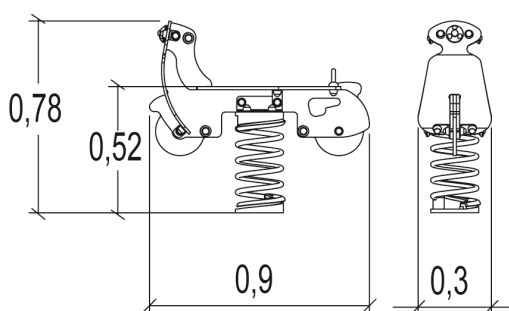

### Funciones Lúdicas : 3

imaginar



x1

columpiarse



x1

equilibrio



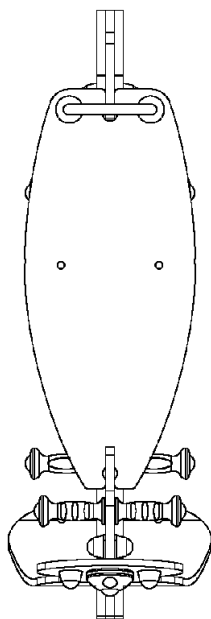

x1

## Elementos constituyentes





## Instalación del equipamiento

Zona de impacto: Superficie de suelo mínima requerida

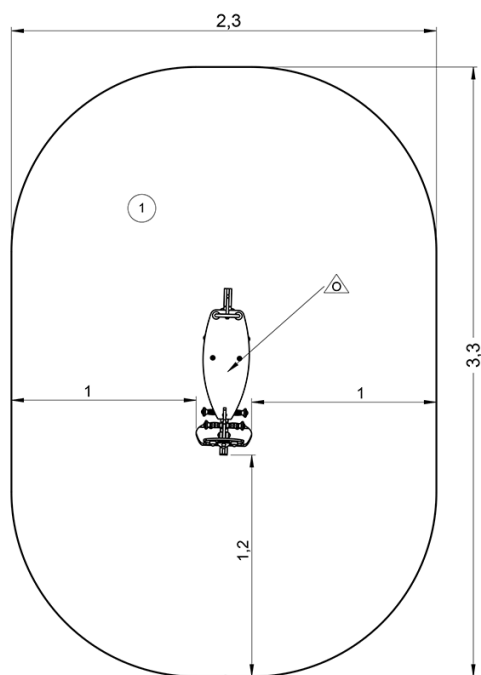
-  Zona de impacto
-  Espacio libre



1	 0,6m	 7m <sup>2</sup>
---	--	---



1

01h00

0m<sup>3</sup>

7m<sup>2</sup>

32kg

10kg

