

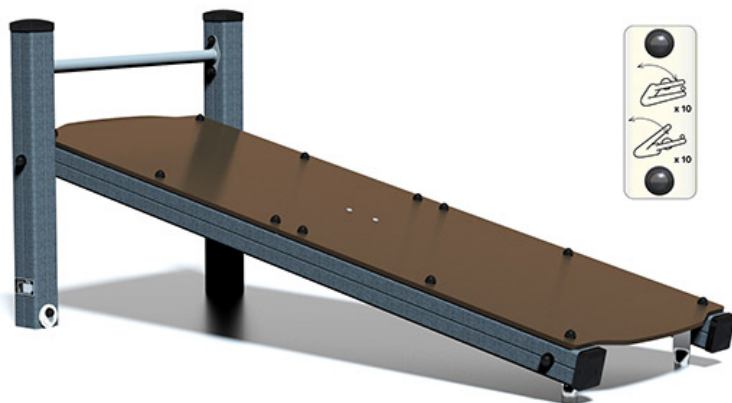

1=2.06m 2=0.94m 3=0.92m

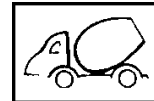

INSTALACIÓN



0.1m³



2

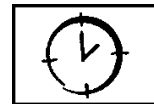

01h30

INFORMACIONES DIVERSAS



1 jugador

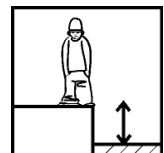

HCL= 0.6m

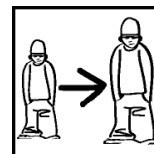

14+

CERTIFICACIONES

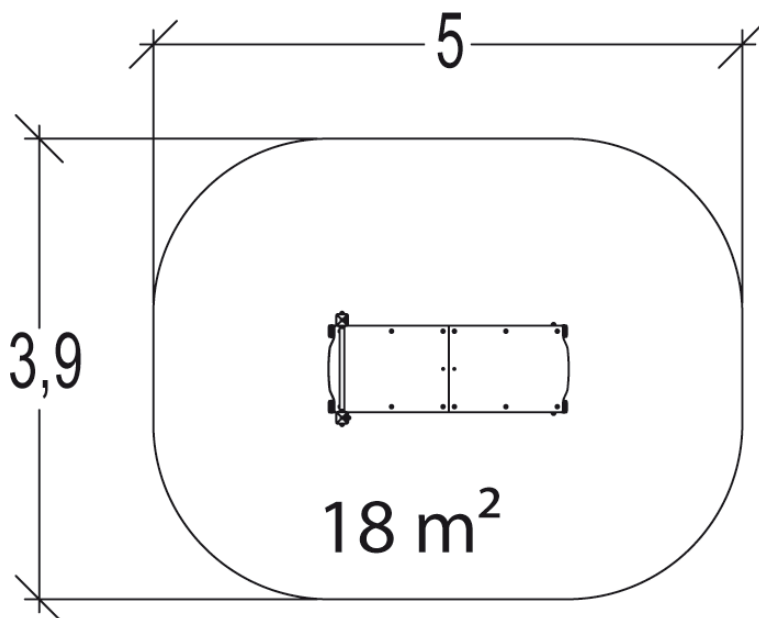
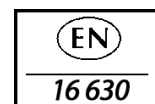

Peso del juego = 77 kg

Elemento más pesado = 13 kg