



2+



1



0,6m



1 = 0,76m

2 = 0,3m

3 = 0,83m



Discapacidad motriz  
Discapacidad sensorial  
Discapacidad mental

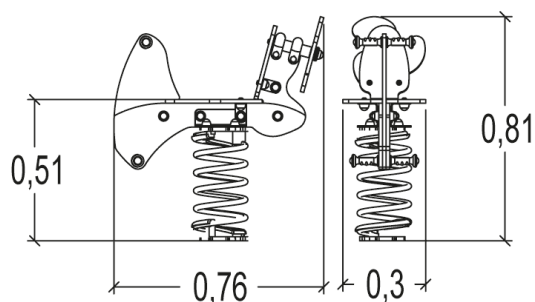

### Funciones Lúdicas : 3

imaginar



x1

columpiarse



x1

equilibrio



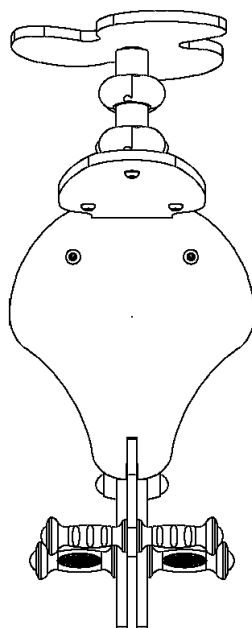

x1

## Elementos constituyentes





## Instalación del equipamiento

Zona de impacto: Superficie de suelo mínima requerida

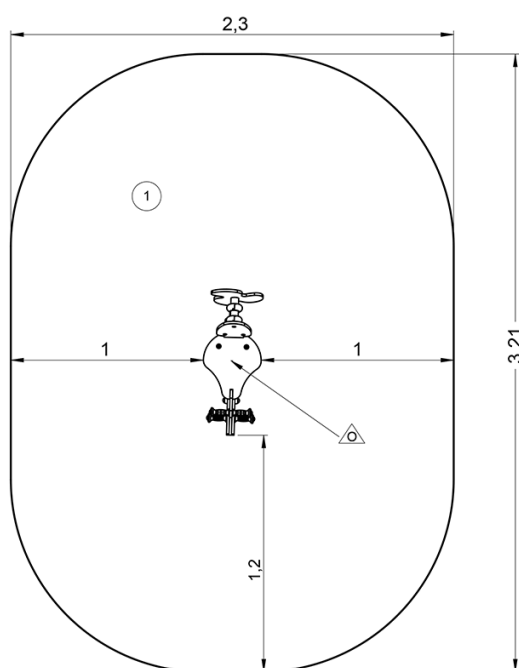
-  Zona de impacto
-  Espacio libre



1	 0,6m	 7m <sup>2</sup>
---	--	---



2



0m<sup>3</sup>



7m<sup>2</sup>



28kg



10kg

