 1=2.29m 2=1.65m 3=1.21m

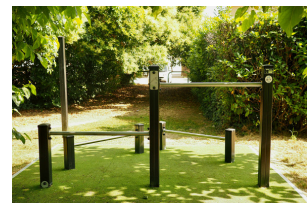

INSTALACIÓN

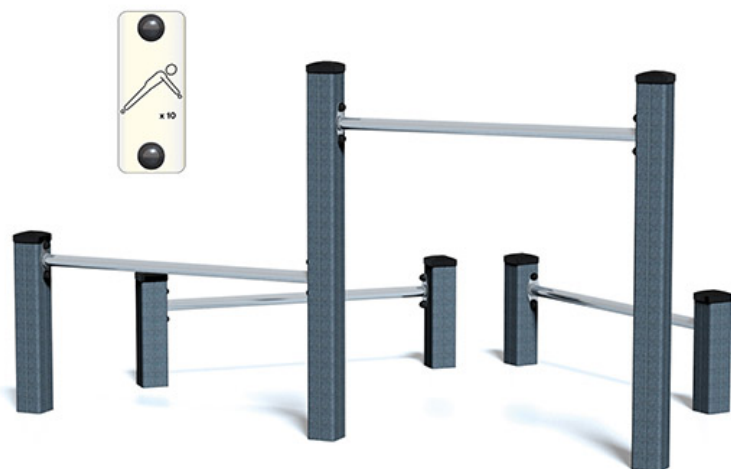

0.2m³

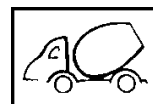

1

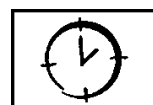

01h30

INFORMACIONES DIVERSAS



2 jugadores

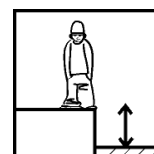

HCL= 1m

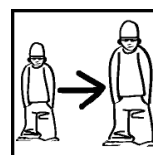

14+

CERTIFICACIONES

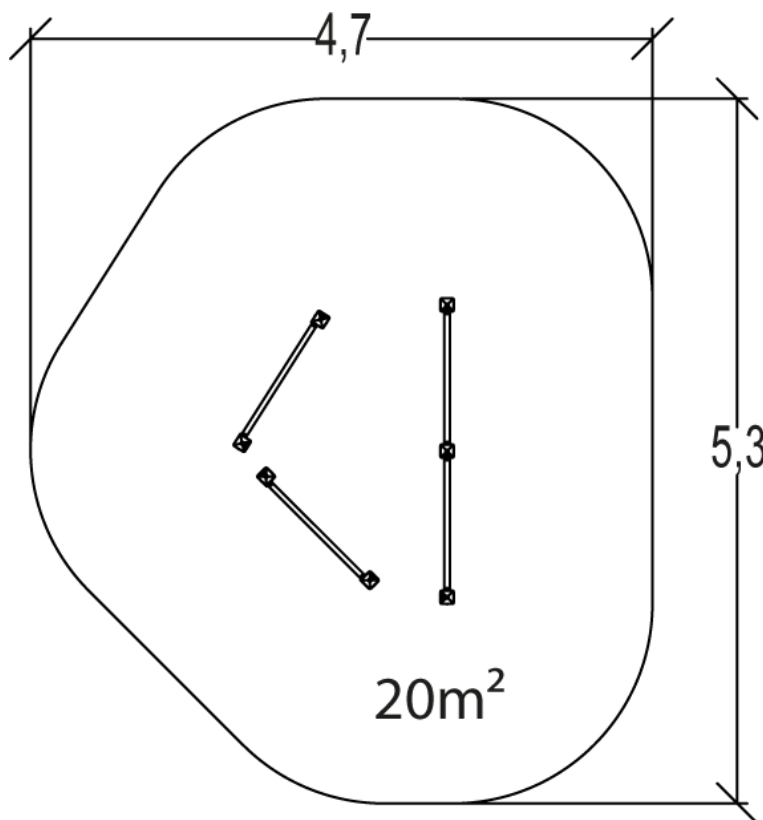
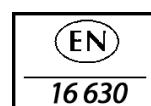

Peso del juego = 69 kg

Elemento más pesado = 12 kg