 1=2.3m 2=0.1m 3=2.02m

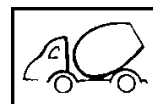

INSTALACIÓN



0.1m³



1

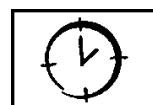

01h00

INFORMACIONES DIVERSAS



2 jugadores

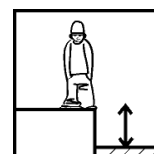

HCL= 1.8m

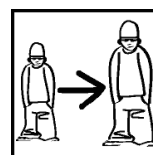

14+

CERTIFICACIONES

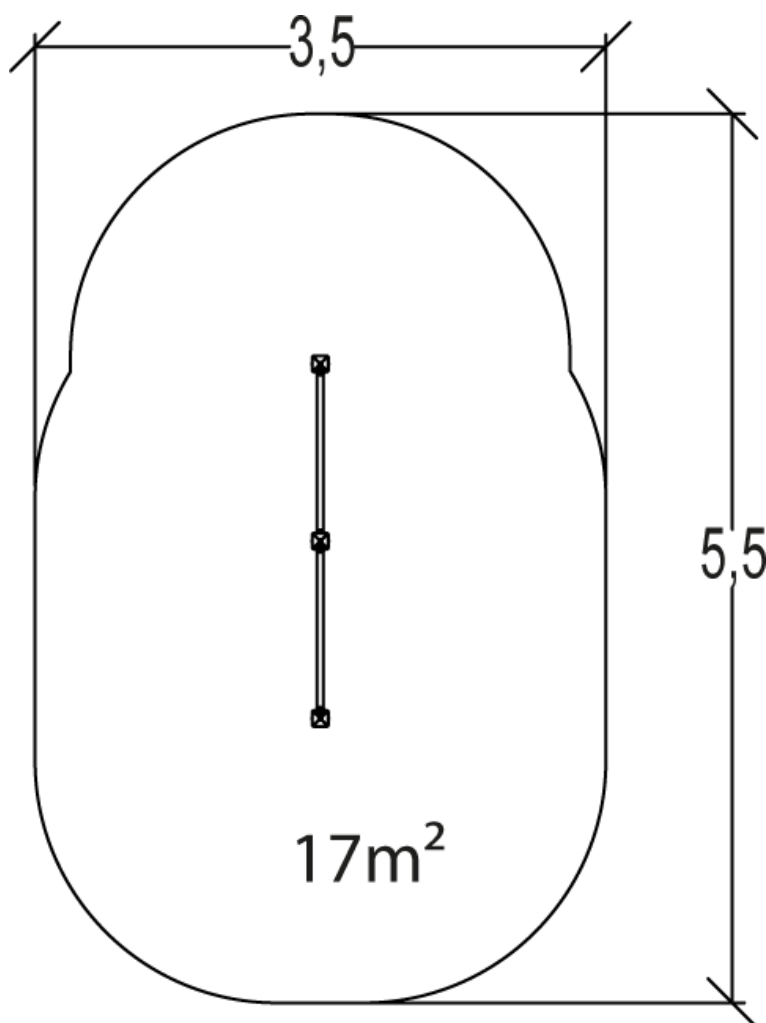
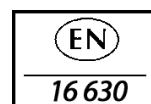

Peso del juego = 54 kg

Elemento más pesado = 17 kg