 1=4.69m 2=0.1m 3=0.62m

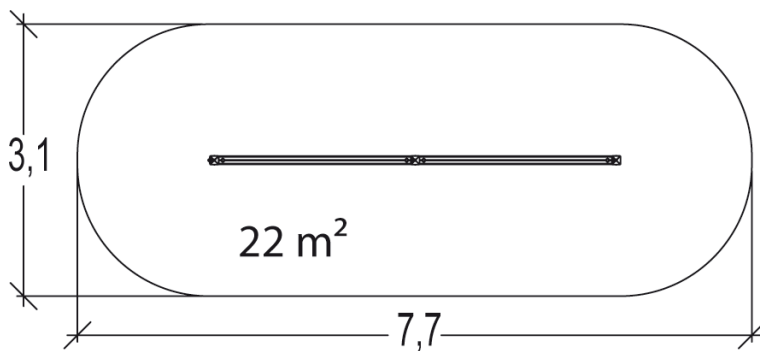

**INSTALACIÓN**

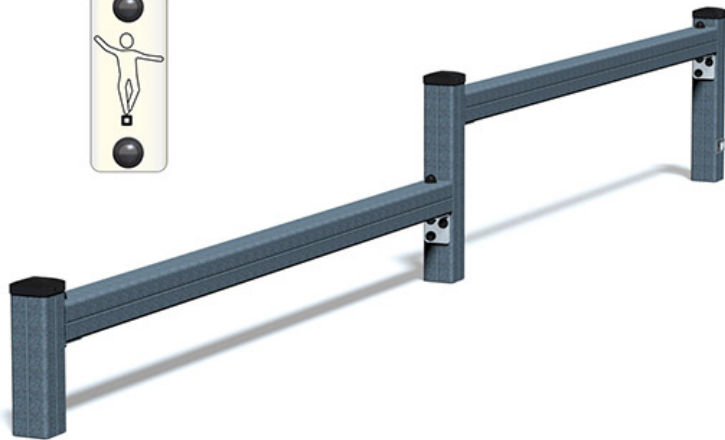

0.1m<sup>3</sup>

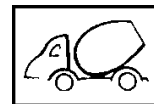

1

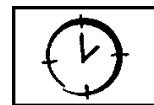

01h00

**INFORMACIONES DIVERSAS**



2 jugadores

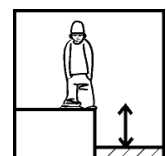

HCL= 0.6m

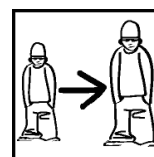

6+

**CERTIFICACIONES**

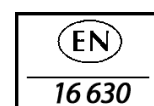

Peso del juego = 53 kg

Elemento más pesado = 14 kg