 1=2.4m 2=0.65m 3=2.51m

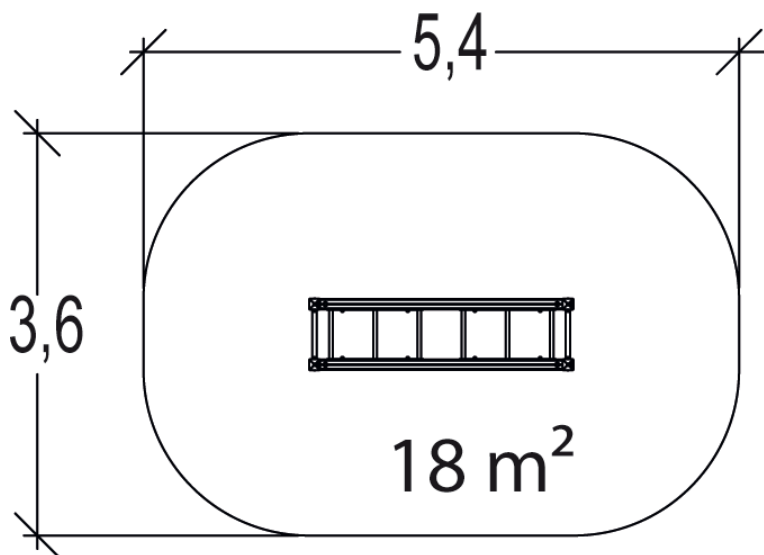

INSTALACIÓN

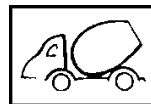

0.1m³



2

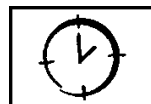

01h45

INFORMACIONES DIVERSAS



2 jugadores

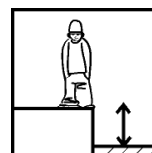

HCL= 1.4m

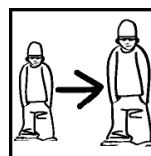

14+

CERTIFICACIONES

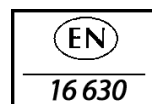

Peso del juego = 133 kg

Elemento más pesado = 20 kg