



2+



10



0,6m



1 = 2,3m
2 = 1,4m
3 = 1,9m



Discapacidad motriz
Discapacidad sensorial
Discapacidad mental

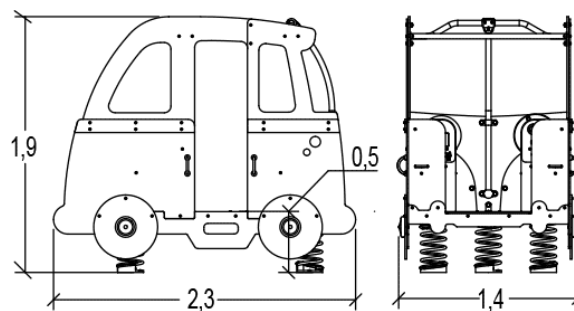
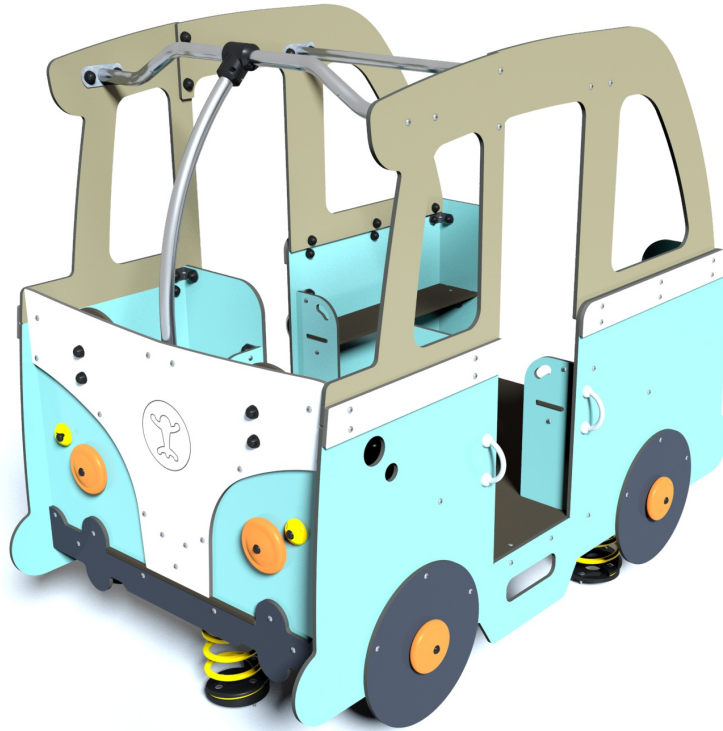

Funciones Lúdicas : 9

imaginar



x1

encontrarse



x1

descansar



x1

manipular



x2

equilibrio



x1

reflexionar



x1

estimulación táctil



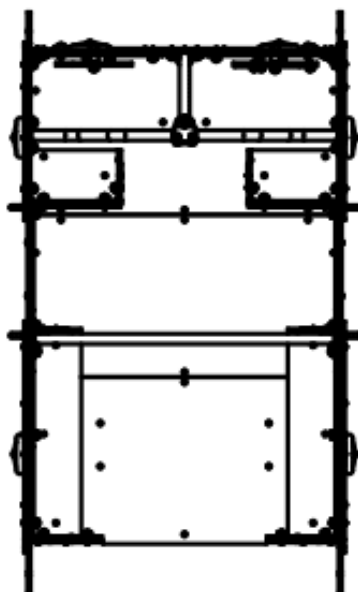

x2

Elementos constituyentes





Instalación del equipamiento

Zona de impacto: Superficie de suelo mínima requerida

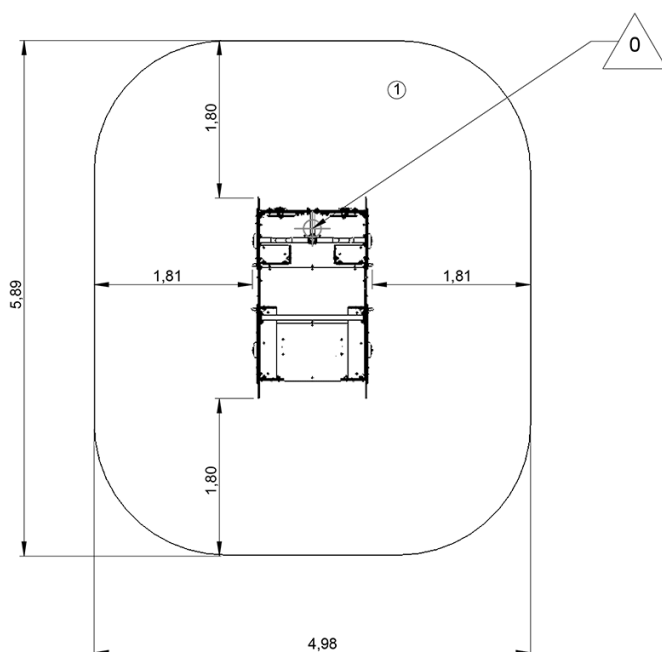
-  Zona de impacto
-  Espacio libre



1	 0,6m	 27,5m ²
---	--	--



2



5h00



0m³



27.5m²



302kg



13kg

