

1=24.5m 2=12.7m 3=3.9m

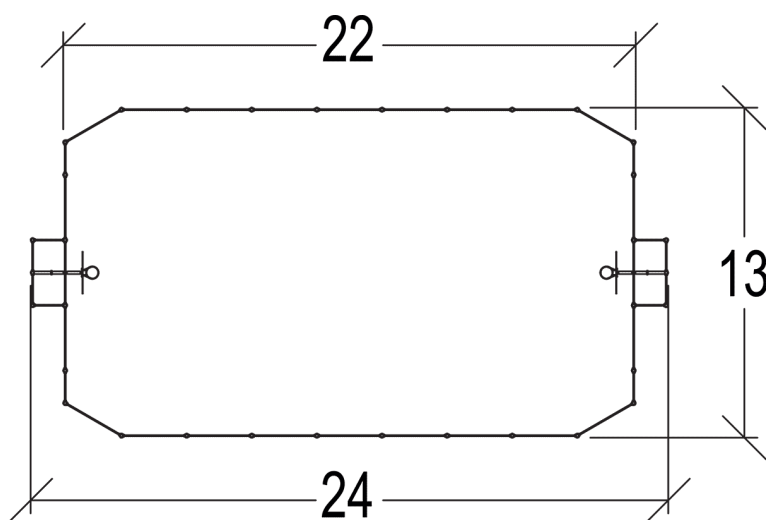

INSTALACIÓN

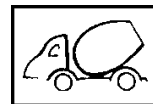

3.4m³



3

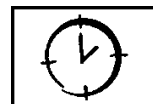

24h00

INFORMACIONES DIVERSAS

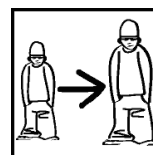

6+

CERTIFICACIONES

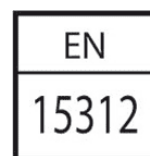

Peso del juego = 1343 kg

Elemento más pesado = 27 kg