



2-8



1



0,6m



1 = 0,74m
2 = 0,37m
3 = 0,84m



Discapacidad motriz
Discapacidad sensorial
Discapacidad mental

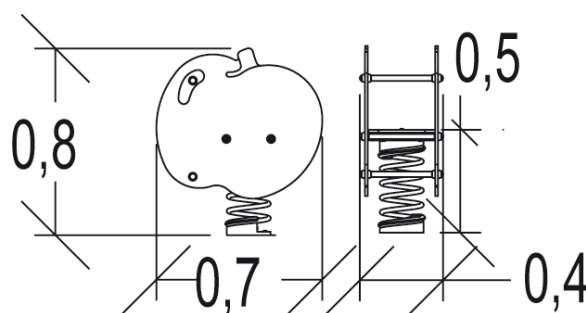

Funciones Lúdicas : 3

imaginar



x1

columpiarse



x1

equilibrio



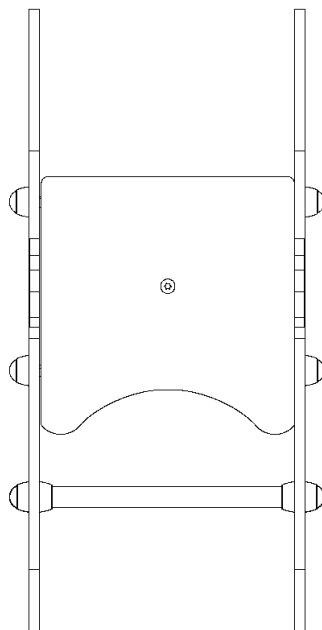

x1

Elementos constituyentes





Instalación del equipamiento

Zona de impacto: Superficie de suelo mínima requerida

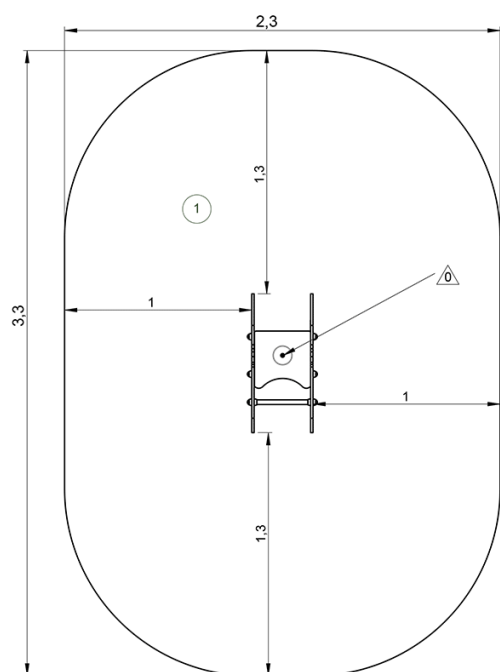
-  Zona de impacto
-  Espacio libre



1	 0,6m	 7m ²
---	--	---



1



01h00



0m³



7m²



36kg



11kg

