

Discapacidad motriz
 Discapacidad sensorial
 Discapacidad mental

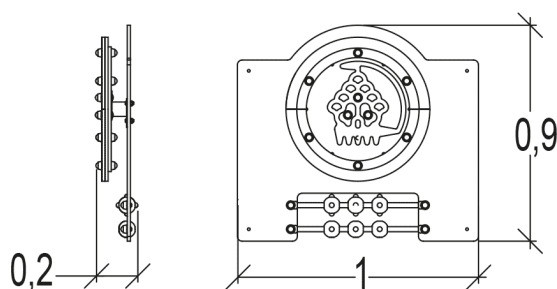

Para instalar con los postes G3422/G3425

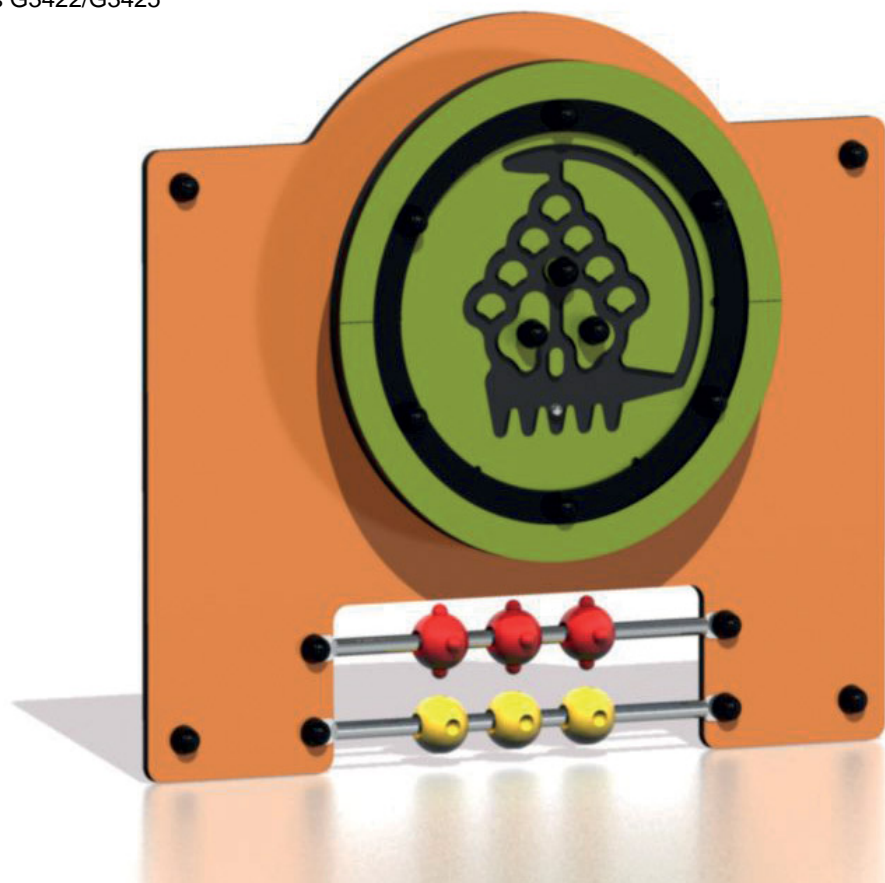

Funciones Lúdicas : 4

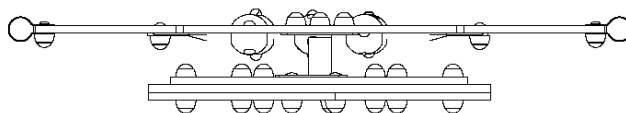

encontrarse	manipular	reflexionar	estimulación táctil
x1	x1	x1	x1

Elementos constituyentes





Instalación del equipamiento

Zona de impacto: Superficie de suelo mínima requerida

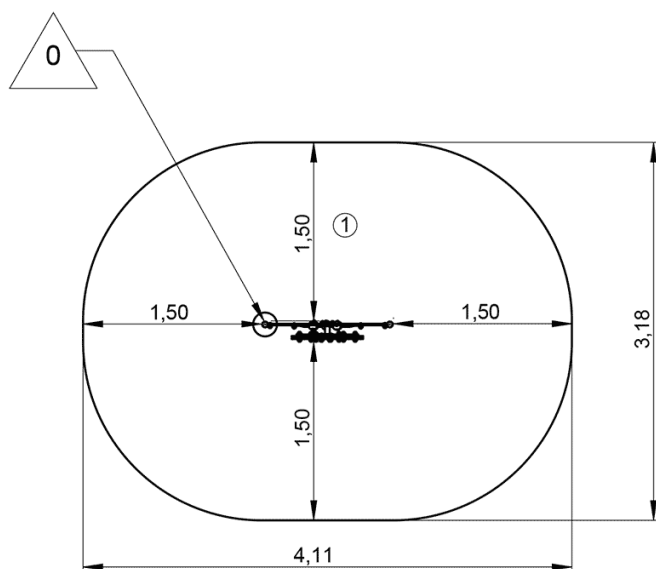
-  Zona de impacto
-  Espacio libre



1	 0m	 11m ²
---	--	--



2



00h45



0m³



11m²



33kg



17kg

